

NAIS

MOST ADVANCED POLARIZED RELAY

TQ-RELAYS

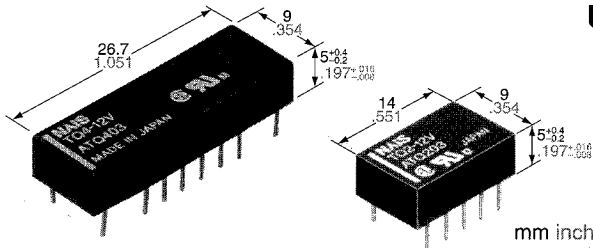

UL File No.: E43149; CSA File No.: LR26550

- Ultra-small size
- High sensitivity:
 - 2 Form C: 140 mW power consumption (single side stable type)
 - 4 Form C: 280 mW power consumption (single side stable type)
- Surge voltage withstand: 1500 V FCC Part 68
- Sealed construction allows automatic washing
- Self-clinching terminal also available
- M.B.B. contact types available

SPECIFICATIONS

Contact		Standard (B.B.M.) type		M.B.B. type
Arrangement		2 Form C	4 Form C	2 Form D
Initial contact resistance, max. (By voltage drop 6 V DC 1 A)		50 mΩ		
Contact material		Gold-clad silver		
Rating	Nominal switching capacity (resistive load)	1 A 30 V DC 0.5 A 125 V AC	1 A 30 V DC	
	Max. switching power (resistive load)	30 W, 62.5 V A		30 W
	Max. switching voltage	110 V DC, 125 V AC		110 V DC
	Max. switching current	1 A		
	Min. switching capability	10 μA 10 m V DC		
Nominal operating power	Single side stable	140 mW (3 to 12 V DC) 200 mW (24 V DC) 300 mW (48 V DC)	280 mW (3 to 24 V DC) 400 mW (48 V DC)	200 mW
	1 coil latching	100 mW (3 to 12 V DC) 150 mW (24 V DC)	200 mW	—
	2 coil latching	200 mW (3 to 12 V DC) 300 mW (24 V DC)	400 mW	—
UL/CSA rating		1 A 30 V DC 0.3 A 110 V DC 0.5 A 125 V AC		
Expected life (min. operations)	Mechanical (at 180 cpm)	10 ⁸	10 ⁷	
	Electrical (at 20 cpm)	1 A 30 V DC resistive	2×10 ⁵	10 ⁵
0.5 A 125 V AC resistive		10 ⁵	—	

Remarks:

- *1 Measurement at same location as "Initial breakdown voltage" section.
- *2 By resistive method, nominal voltage applied to the coil; contact carrying current: 1 A.
- *3 Nominal voltage applied to the coil, excluding contact bounce time.
- *4 Nominal voltage applied to the coil, excluding contact bounce time without diode.
- *5 Half-wave pulse of sine wave: 11 msec.; detection time: 10 μsec.
- *6 Half-wave pulse of sine wave: 6 msec.
- *7 Detection time: 10 μsec.

Characteristics

Characteristics		Standard (B.B.M.) type	M.B.B. type
Initial insulation resistance*1		Min. 1,000 MΩ (at 500 V DC)	
Initial break-down voltage	Between open contacts	750 Vrms for 1 min. (Detection current: 10 mA)	300 Vrms for 1 min. (Detection current: 10 mA)
	Between contact and coil	1,000 Vrms for 1 min. (Detection current: 10 mA)	
	Between contact sets	1,000 Vrms for 1 min. (Detection current: 10 mA)	
FCC surge voltage between open contacts		1,500 V	
Temperature rise*2 (at 20°C)		Max. 50°C	
Operate time [Set time]*3 (at 20°C)		Max. 3 msec. (Approx. 2 msec.) [Max. 3 msec. (Approx. 2 msec.)]	
Release time [Reset time]*4 (at 20°C)		Max. 3 msec. (Approx. 1 msec.) [Max. 3 msec. (Approx. 2 msec.)]	
M.B.B. time*8		—	Min: 10 μsec.
Shock resistance	Functional*5	Min. 490 m/s ² {50G}	
	Destructive*6	Min. 980 m/s ² {100 G}	
Vibration resistance	Functional*7	176.4 m/s ² {18G}, 10 to 55 Hz at double amplitude of 3 mm	
	Destructive	294 m/s ² {30G}, 10 to 55 Hz at double amplitude of 5 mm	
Conditions for operation, transport and storage (Not freezing and condensing at low temperature)	Ambient temperature	-40°C to +70°C -40°F to +158°F	-40°C to +50°C -40°F to +122°F
	Humidity	5 to 85% R.H.	
Unit weight	2 Form C:	Approx. 1.5 g .053 oz	
	4 Form C:	Approx. 3 g .106 oz	—

*8 M.B.B. time:

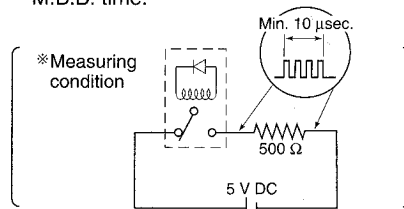

ORDERING INFORMATION

EX. TQ 2 H — L2 — 2M — 3V

Contact arrangement	Terminal shape	Operating function	MBB function	Coil voltage (DC)
2: 2 Form C 4: 4 Form C	Nil: Standard PC board terminal H: Self-clinching terminal	Nil: Single side stable L: 1 coil latching L2: 2 coil latching	Nil: Standard (B.B.M.) type 2M: 2M.B.B. type	3, 4.5, 5, 6, 9, 12, 24, 48* V

*48 V coil type: Single side stable only
 Notes: 1. AgPd stationary contact types available for high resistance against contact sticking. When ordering, please add suffix “-3” like TQ2-12V-3.
 2. M.B.B. contact types are available only for TQ2 type.

TYPES AND COIL DATA (at 20°C 68°F)

1. Standard (B.B.M.) type

① **2 Form C type**

Operating function	Part No.		Nominal voltage, V DC	Pick-up voltage, V DC (max.)	Drop-out voltage, V DC (min.)	Nominal operating current, mA (±10%)	Coil resistance, Ω (±10%)	Nominal operating power, mW	Max. allowable voltage, V DC
	Standard PC board terminal	Self-clinching terminal							
Single side stable	TQ2-3 V	TQ2H-3 V	3	2.25	0.3	46.7	64.3	140	4.5
	TQ2-4.5 V	TQ2H-4.5 V	4.5	3.38	0.45	31.1	144.6	140	6.7
	TQ2-5 V	TQ2H-5 V	5	3.75	0.5	28.1	178	140	7.5
	TQ2-6 V	TQ2H-6 V	6	4.5	0.6	23.3	257	140	9
	TQ2-9 V	TQ2H-9 V	9	6.75	0.9	15.5	579	140	13.5
	TQ2-12 V	TQ2H-12 V	12	9	1.2	11.7	1,028	140	18
	TQ2-24 V	TQ2H-24 V	24	18	2.4	8.3	2,880	200	36
	TQ2-48 V	TQ2H-48 V	48	36	4.8	6.25	7,680	300	57.6

Operating function	Part No.		Nominal voltage, V DC	Set voltage, V DC (max.)	Reset voltage, V DC (max.)	Nominal operating current, mA (±10%)	Coil resistance, Ω (±10%)	Nominal operating power, mW	Max. allowable voltage, V DC
	Standard PC board terminal	Self-clinching terminal							
1 Coil latching	TQ2-L-3 V	TQ2H-L-3 V	3	2.25	2.25	33.3	90	100	4.5
	TQ2-L-4.5 V	TQ2H-L-4.5 V	4.5	3.38	3.38	22.2	202.5	100	6.7
	TQ2-L-5 V	TQ2H-L-5 V	5	3.75	3.75	20	250	100	7.5
	TQ2-L-6 V	TQ2H-L-6 V	6	4.5	4.5	16.7	360	100	9
	TQ2-L-9 V	TQ2H-L-9 V	9	6.75	6.75	11.1	810	100	13.5
	TQ2-L-12 V	TQ2H-L-12 V	12	9	9	8.3	1,440	100	18
	TQ2-L-24 V	TQ2H-L-24 V	24	18	18	6.3	3,840	150	36
2 Coil latching	TQ2-L2-3 V	TQ2H-L2-3 V	3	2.25	2.25	66.7	45	200	4.5
	TQ2-L2-4.5 V	TQ2H-L2-4.5 V	4.5	3.38	3.38	44.4	101.2	200	6.7
	TQ2-L2-5 V	TQ2H-L2-5 V	5	3.75	3.75	40	125	200	7.5
	TQ2-L2-6 V	TQ2H-L2-6 V	6	4.5	4.5	33.3	180	200	9
	TQ2-L2-9 V	TQ2H-L2-9 V	9	6.75	6.75	22.2	405	200	13.5
	TQ2-L2-12 V	TQ2H-L2-12 V	12	9	9	16.7	720	200	18
	TQ2-L2-24 V	TQ2H-L2-24 V	24	18	18	12.5	1,920	300	28.8

Notes: 1. Specified value of the pick-up, drop-out, set and reset voltage is with the condition of square wave coil pulse.
 2. Standard packing: Tube: 50 pcs.; Case: 1,000 pcs.
 3. In case of 5V transistor drive circuit, it is recommend to use 4.5V type relay.

② **4 Form C type**

Operating function	Part No.		Nominal voltage, V DC	Pick-up voltage, V DC (max.)	Drop-out voltage, V DC (min.)	Nominal operating current, mA (±10%)	Coil resistance, Ω (±10%)	Nominal operating power, mW	Max. allowable voltage, V DC
	Standard PC board terminal	Self-clinching terminal							
Single side stable	TQ4-3 V	TQ4H-3 V	3	2.25	0.3	93.8	32	280	4.5
	TQ4-4.5 V	TQ4H-4.5 V	4.5	3.38	0.45	62.2	72.3	280	6.7
	TQ4-5 V	TQ4H-5 V	5	3.75	0.5	56.2	89	280	7.5
	TQ4-6 V	TQ4H-6 V	6	4.5	0.6	46.5	129	280	9
	TQ4-9 V	TQ4H-9 V	9	6.75	0.9	31.1	289	280	13.5
	TQ4-12 V	TQ4H-12 V	12	9	1.2	23.3	514	280	18
	TQ4-24 V	TQ4H-24 V	24	18	2.4	11.7	2,056	280	36
	TQ4-48 V	TQ4H-48 V	48	36	4.8	8.3	5,760	400	57.6

Operating function	Part No.		Nominal voltage, V DC	Set voltage, V DC (max.)	Reset voltage, V DC (max.)	Nominal operating current, mA (±10%)	Coil resistance, Ω (±10%)	Nominal operating power, mW	Max. allowable voltage, V DC
	Standard PC board terminal	Self-clinching terminal							
1 Coil latching	TQ4-L-3 V	TQ4H-L-3 V	3	2.25	2.25	66.6	45	200	4.5
	TQ4-L-4.5 V	TQ4H-L-4.5 V	4.5	3.38	3.38	44.4	101.2	200	6.7
	TQ4-L-5 V	TQ4H-L-5 V	5	3.75	3.75	40	125	200	7.5
	TQ4-L-6 V	TQ4H-L-6 V	6	4.5	4.5	33.3	180	200	9
	TQ4-L-9 V	TQ4H-L-9 V	9	6.75	6.75	22.2	405	200	13.5
	TQ4-L-12 V	TQ4H-L-12 V	12	9	9	16.7	720	200	18
	TQ4-L-24 V	TQ4H-L-24 V	24	18	18	8.3	2,880	200	36
2 Coil latching	TQ4-L2-3 V	TQ4H-L2-3 V	3	2.25	2.25	133	22.5	400	4.5
	TQ4-L2-4.5 V	TQ4H-L2-4.5 V	4.5	3.38	3.38	88.9	50.6	400	6.7
	TQ4-L2-5 V	TQ4H-L2-5 V	5	3.75	3.75	80	62.5	400	7.5
	TQ4-L2-6 V	TQ4H-L2-6 V	6	4.5	4.5	66.6	90	400	9
	TQ4-L2-9 V	TQ4H-L2-9 V	9	6.75	6.75	44.4	202.5	400	13.5
	TQ4-L2-12 V	TQ4H-L2-12 V	12	9	9	33.3	360	400	18
	TQ4-L2-24 V	TQ4H-L2-24 V	24	18	18	16.7	1,440	400	36

Notes: 1. Specified value of the pick-up, drop-out, set and reset voltage is with the condition of square wave coil pulse.
 2. Standard packing: Tube: 25 pcs.; Case: 500 pcs.
 3. In case of 5 V transistor drive circuit, it is recommend to use 4.5 V type relay.

2. M.B.B. type

Operating function	Part No.		Nominal voltage, V DC	Pick-up voltage, V DC (max.)	Drop-out voltage, V DC (min.)	Nominal operating current, mA (±10%)	Coil resistance, Ω (±10%)	Nominal operating power, mW	Max. allowable voltage, V DC
	Standard PC board terminal	Self-clinching terminal							
Single side stable	TQ2-2M-3 V	TQ2H-2M-3 V	3	2.4	0.3	66.7	45	200	4.5
	TQ2-2M-4.5 V	TQ2H-2M-4.5 V	4.5	3.6	0.45	44.4	101	200	6.7
	TQ2-2M-5 V	TQ2H-2M-5 V	5	4	0.5	40	125	200	7.5
	TQ2-2M-6 V	TQ2H-2M-6 V	6	4.8	0.6	33.3	180	200	9
	TQ2-2M-9 V	TQ2H-2M-9 V	9	7.2	0.9	22.2	405	200	13.5
	TQ2-2M-12 V	TQ2H-2M-12 V	12	9.6	1.2	16.7	720	200	18
	TQ2-2M-24 V	TQ2H-2M-24 V	24	19.2	2.4	8.3	2,880	200	36

Notes: 1. Specified value of the pick-up, drop-out, voltage is with the condition of square wave coil pulse.
 2. Standard packing: Tube: 50 pcs.; Case: 1,000 pcs.
 3. In case of 5V transistor drive circuit, it is recommend to use 4.5V type relay.
 4. 1 coil latching and 2 coil latching types are also available by request. Please consult us for details.

DIMENSIONS

1) 2 Form C, 2 Form D

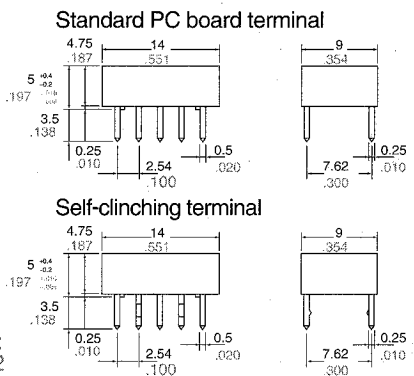

PC board pattern (Copper-side view)

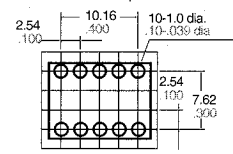

Schematic (Bottom view)

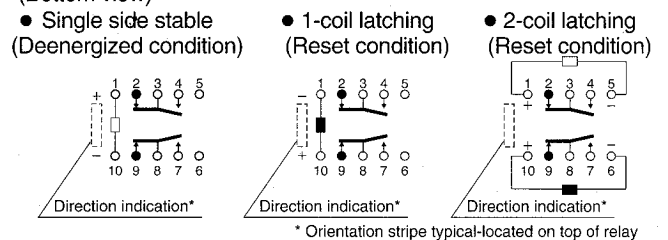

2) 4 Form C

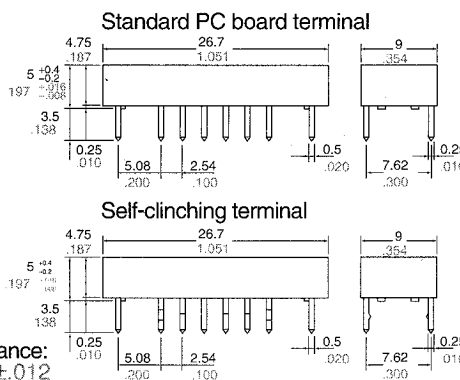
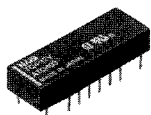

PC board pattern (Copper-side view)

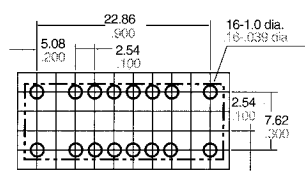

Schematic (Bottom view)

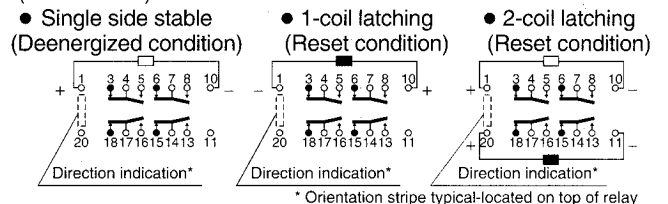

DATA

1. Maximum switching capacity

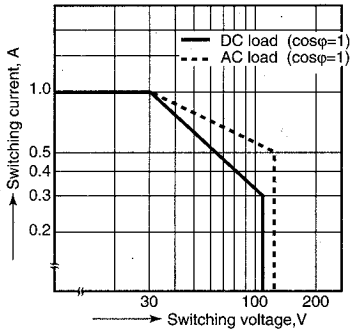

2. Life curve

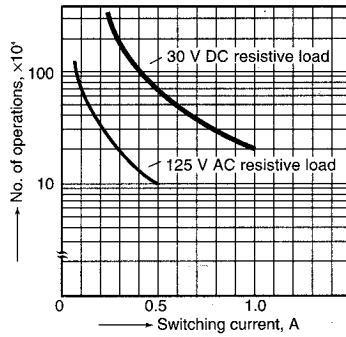

3. Mechanical life

Tested sample: TQ2-12V, 10 pcs.

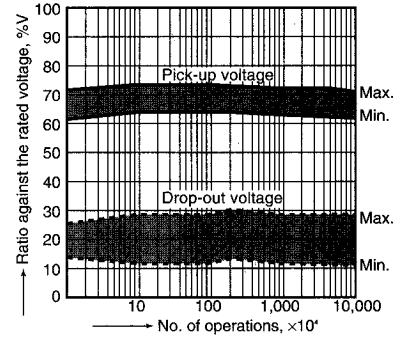

4.-(1) Electrical life (DC load)

Tested sample: TQ2-12V, 6 pcs.

Condition: 1 A 30 V DC resistive load, 20 cpm

Change of pick-up and drop-out voltage

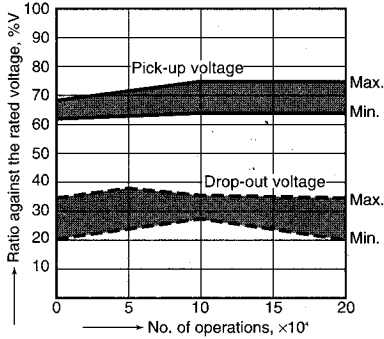

4.-(2) Electrical life (AC load)

Tested sample: TQ2-12V, 6 pcs.

Condition: 0.5 A 125 V AC resistive load, 20 cpm

Change of pick-up and drop-out voltage

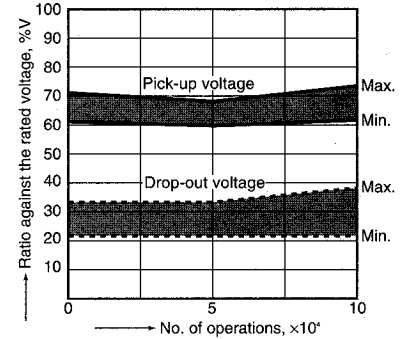

Change of contact resistance

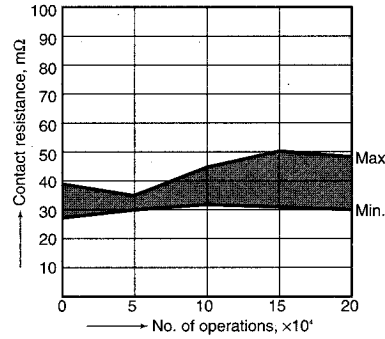

Change of contact resistance

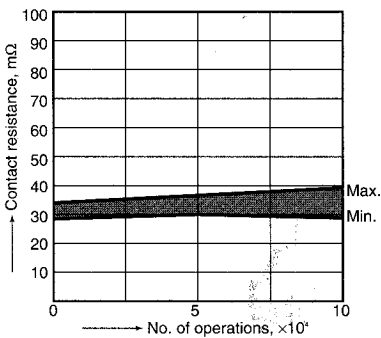

5.-(1) Coil temperature rise (2C)

Tested sample: TQ2-12V

Measured portion: Inside the coil

Ambient temperature: 30°C 86°F

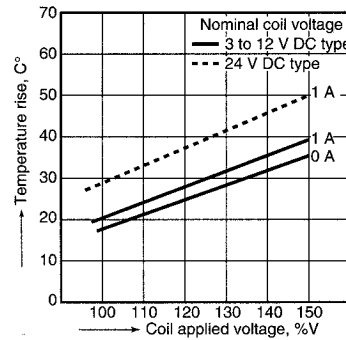

5.-(2) Coil temperature rise (4c)

Tested sample: TQ4-12V

Measured portion: Inside the coil

Ambient temperature: 30°C 86°F

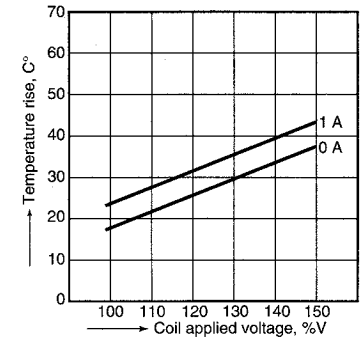

6.-(1) Operate/release time characteristics

Tested sample: TQ2-12V, 10 pcs.

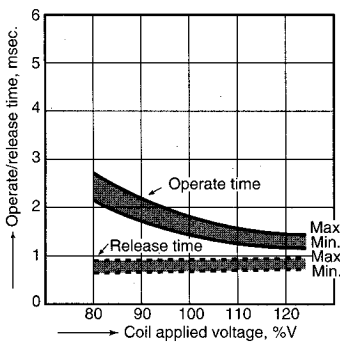

6.-(2) Operate/release time characteristics

Tested sample: TQ4-12V, 10 pcs.

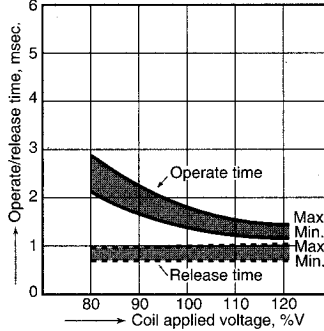

7. Distribution of pick-up and drop-out voltages

Tested sample: TQ2-12V, 50 pcs.

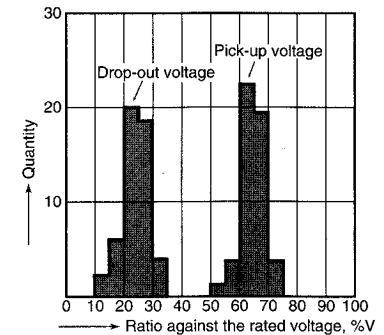

8. Distribution of set and reset voltage
Tested sample: TQ2-L2-12V, 35 pcs.

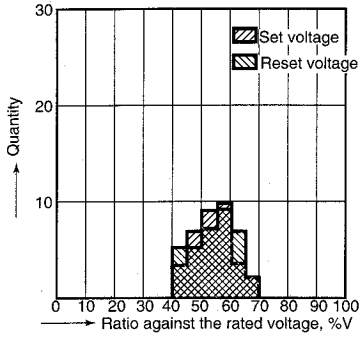

9. Ambient temperature characteristics
Tested sample: TQ2-12V, 5 pcs.

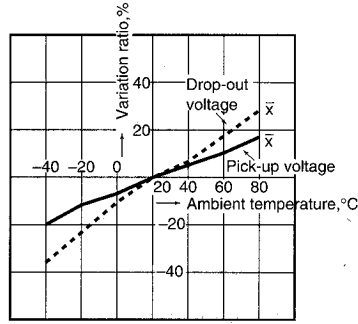

10. Distribution of contact resistance
Tested sample: TQ2-12V, 30 pcs. (30x4 contacts)

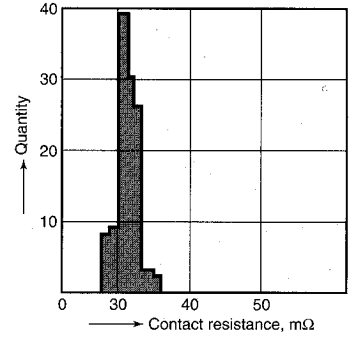

11.-(1) High-frequency characteristics
Isolation characteristics

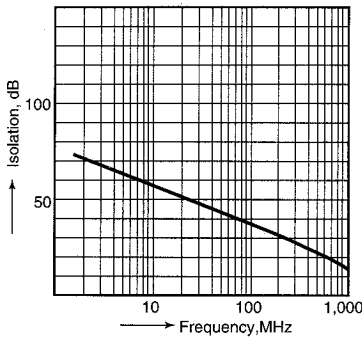

11.-(2) High-frequency characteristics
Insertion loss characteristics

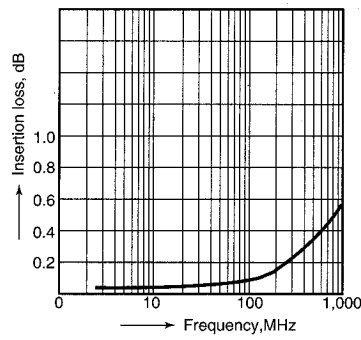

11.-(3) High-frequency characteristics
V.S.W.R.

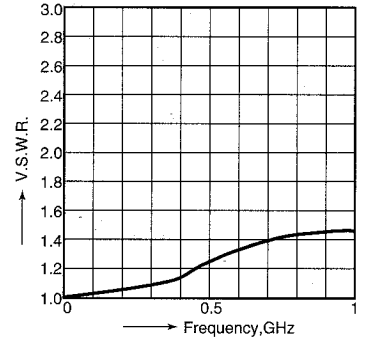

12.-(1) Malfunctional shock (single side stable)
Tested sample: TQ2-12V, 6 pcs.

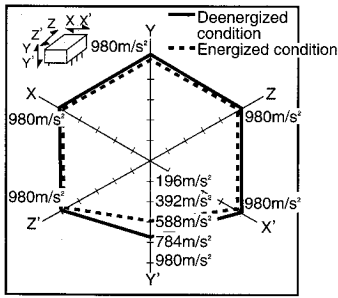

12.-(2) Malfunctional shock (latching)
Tested sample: TQ2-L-12V, 6 pcs.

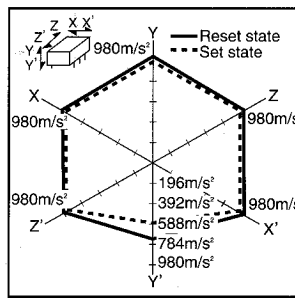

13.-(1) Influence of adjacent mounting

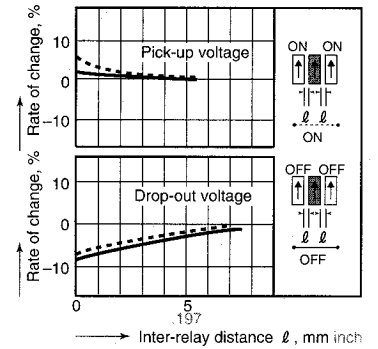

13.-(2) Influence of adjacent mounting

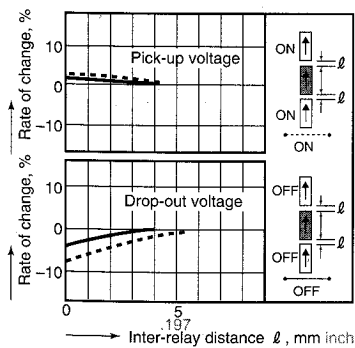

13.-(3) Influence of adjacent mounting

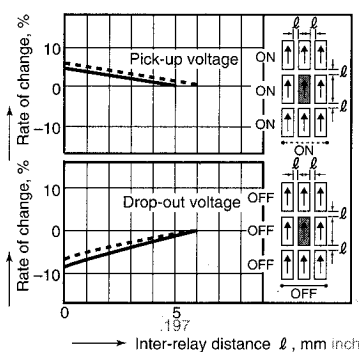

14.-(1) Contact reliability
(1 mA 5 V DC resistive load)
Tested sample: TQ2-12V
Condition: Detection level 10 Ω

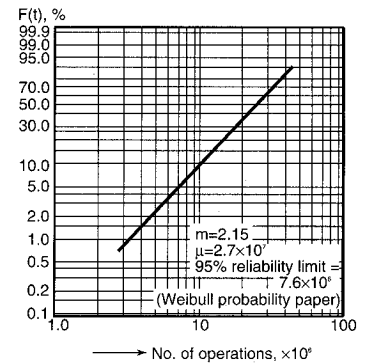

14.-(2) Contact reliability
 (100 μ A 5 V DC resistive load)
 Tested sample: TQ2-12V
 Condition: Detection level 100 Ω

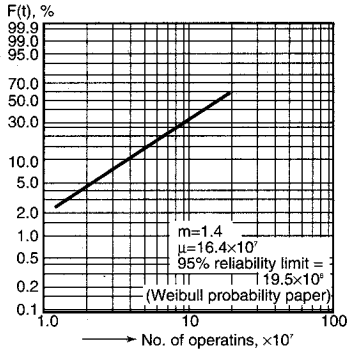

15. Actual load test (35 mA 48V DC wire spring relay load)

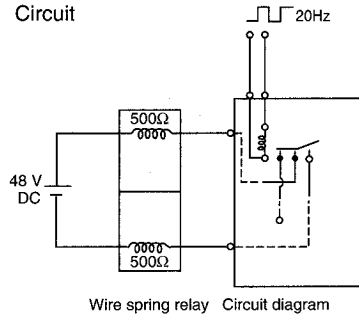

Change of pick-up and drop-out voltage

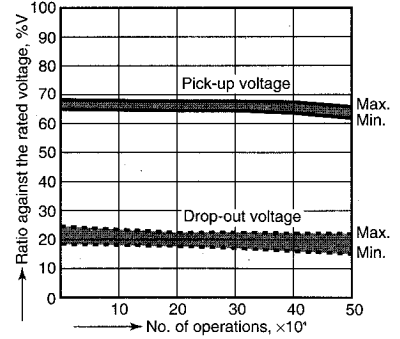

Change of contact resistance

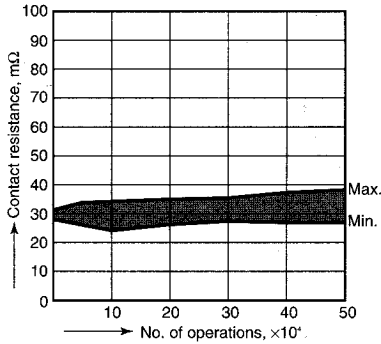

16. 0.1 A 53 V DC resistive load test
 Change of pick-up and drop-out voltage

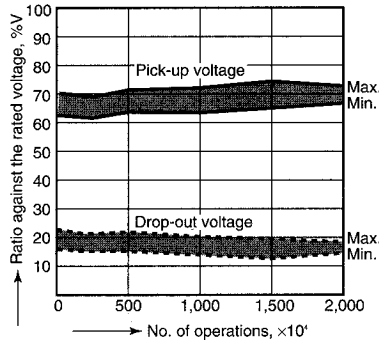

Change of contact resistance

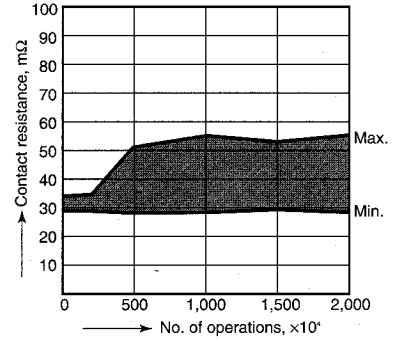

17.-(1) Distribution of M.B.B. time
 Sample: TQ2-2M-5V, 85 pcs.
 Terminal Nos. 2-3-4: ON

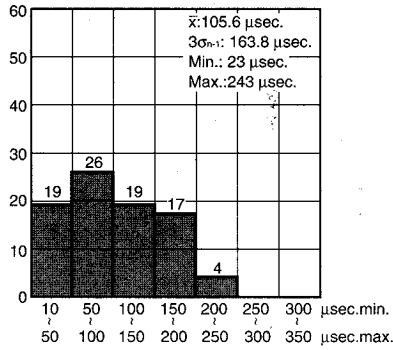

Terminal Nos. 2-3-4: OFF

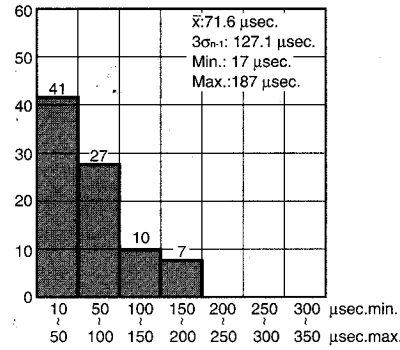

17.-(2) Distribution of M.B.B. time
 Sample: TQ2-2M-5V, 85 pcs.
 Terminal Nos. 7-8-9: ON

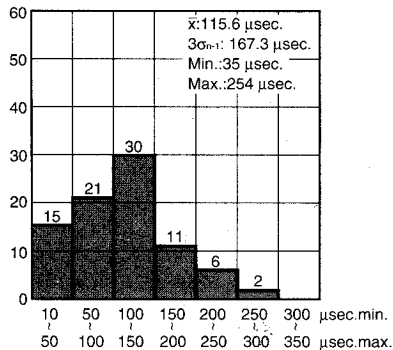

Terminal Nos. 7-8-9: OFF

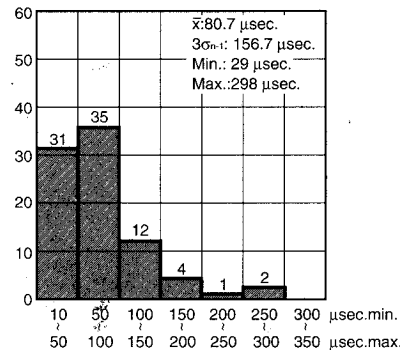

NOTES

1. Coil operating power

Pure DC current should be applied to the coil. The wave form should be rectangular. If it includes ripple, the ripple factor should be less than 5%. However, check it with the actual circuit since the characteristics may be slightly different.

2. Coil connection

When connecting coils, refer to the wiring diagram to prevent mis-operation or malfunction.

3. External magnetic field

Since TQ-relay is highly sensitive polarized relay, its characteristics will be affected by a strong external magnetic field. Avoid using relays under that condition.

4. Cleaning

In automatic cleaning, cleaning with the boiling method is recommended. Avoid ultrasonic cleaning for relays. It is recommended that a fluorinated hydrocarbon or other alcoholic solvents be used.

Trichlene and chloroethene can be used for cleaning.

5. Packing direction

Relays are packed in a tube with the orientation stripe (PIN No. 1) toward the gray stopper.

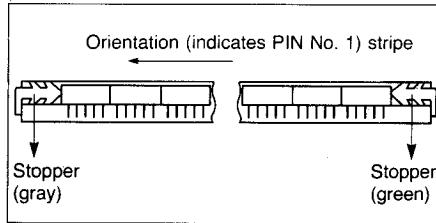

6. Automatic insertion

To maintain the internal function of the relay, the chucking pressure should not exceed the values below.

Chucking pressure in the direction A:

500 g or less*

Chucking pressure in the direction B:

1 kg or less

Mounting pressure in the direction C:

1 kg or less

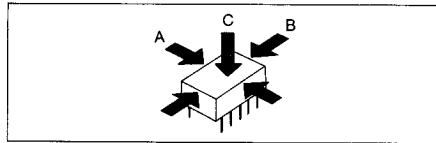

*Avoid chucking the center of the relay.

7. Soldering

Preheat according to the following conditions.

Temperature	100°C 212°F or less
Time	Within 1 minute

Soldering should be done at 250°C 482°F within 5 sec.

8. Others

1) If in error the relay has been dropped, the appearance and characteristics should be checked before use without fail.

2) Latching relays are shipped from the factory in the reset state. A shock to the relay during shipping or installation may cause it to change to the set state. Therefore, it is recommended the relay be used in a circuit which initializes the relay to the required state (set or reset) whenever the power is turned on.